

RADAX PTO shafts

We, at **TRADELINK SERVICES** have established a reputation for design and supply of productivity enhancers like keyless bushes, high flexibility universal joints for low torque conditions and Cardan shafts for heavy torque applications to leading industries all over the country. Our distinction is the quality we offer from leading European companies, our technical service & our vast experience as well as our skills in introducing a fascinating variety of innovative engineering products into India.



With the introduction of mechanization in the agricultural sector **TRADELINK SERVICES** entered this segment in 1998 with the import and distribution of PTO Shafts and Gearboxes from Comer Industries SpA of Italy. Our knowledge and insight of the Indian market made us realize the requirements for an acceptable product at an affordable cost, thus leading us to launch our own brand- Radax PTO shafts in 2008.

Order code for **RADAX** PTO shaft:

Example - R6*560C*4.3*SG*6SBT1

Explanation:

The code represents:

1. **R6:** Model: Based on Torque at 540/1000 rpm
2. **560mm:** Center to Centre length
3. **4.3:** Push pin yoke - (6/21 x 1.3/8" splines)
4. **SG :** Plastic Safety guard
5. **6SBT1:** Safety Device
(Shear Bolt Torque Limiter/Friction Torque Limiter)

Exploded View:

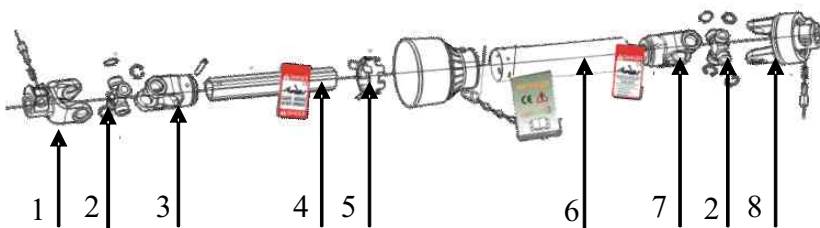

CODE	DESCRIPTION
1.	Push Pin splined yoke, for tractor side
2.	Cross
3.	Outer Tube, Yoke
4.	Outer Tube
5.	Safety Guard
6.	Inner Tube
7.	Inner Tube, Yoke
8.	Shear bolt torque limiter, with push pin splined yoke or Friction Torque Limiter



ISO9001:2000

CE CERTIFICATE

We source our products from proven companies who are ISO certified along with CE certification - proof of the acceptability of their range of products in the international market

RADAX PTO shafts are being successfully used under Indian conditions.



We Bring Perfection To Transmission

TRANSMITTING CAPACITY OF MODELS : TYPE R



SIZE		A (mm)	B (mm)	540 rpm		1000 rpm
1	R1	22	54	Kw	12	18
				Nm	210	170
2	R2	23.8	61.3	Kw	20	30
				Nm	280	230
3	R3	27	70	Kw	24	37
				Nm	400	320
4	R4		74.6	Kw	26	39
				Nm	460	360
5	R5	30.2	80	Kw	35	55
				Nm	620	500
6	R6		92	Kw	40	61
				Nm	850	690
7	R7	106.5	Kw	55	78	
			Nm	1000	810	
8	R8	35	106.5	Kw	66	100
				Nm	1250	1020

YOKE (INNER & OUTER)

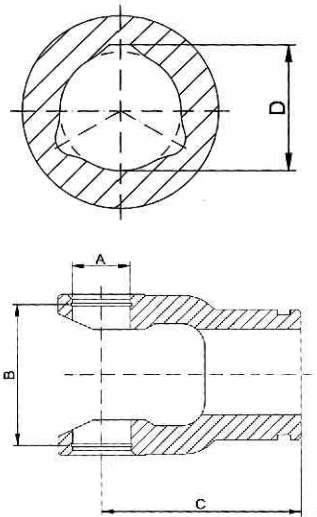

REF	A (mm)	B (mm)	C (mm)	D (mm)
4.0	27	70	92	43.4
4.3		74.6		
4.7				
5.3	30.2	80	98	51.3
5.7				44.7
6.3				53.6
6.7				44.7
8.3	35	106.5	127	62.7
8.7				53.6

CROSS

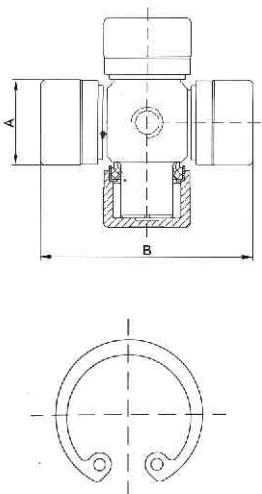

SIZE	REF	A (mm)	B (mm)
1	1.01	22	54
2	2.01	23.8	61.3
3	3.01	27	70
4	4.01	27	74.6
5	5.01	30.2	80
6	6.01	30.2	92
7	7.01	30.2	106.5
8	8.01	35	106.5
38	38.02	38	57

SPLINED YOKE

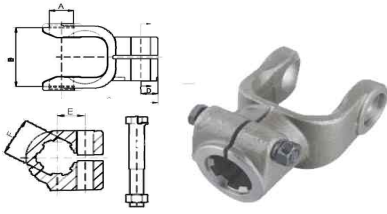

REF	B (mm)	C (mm)	E (mm)	F (mm)
4.1	74.6	107	22	13/8"Z6
5.1	80	109		
6.1	92	116		
8.1	35	124		

OTHER YOKES

Yokes with bore/keyway and split hubs are also available against request

SHEAR BOLT TORQUE LIMITERS (SBT)

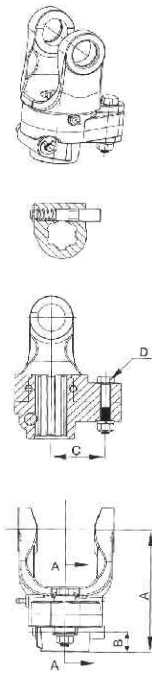

SIZE	REF	TORQUE Nm	SPLINE (FEMALE)	A (mm)	B (mm)	C (mm)	D (mm)		
1	1SB	650	13/8"Z6	95	19	45	M6 x 40		
	1SBT1	650				55			
2	2SB	900		99		45			
	2SBT1	950				48			
3	SB	1280		102		38			
	3SBT1	1300				40			
4SB	4SB	1480		107		48			
	4SBT1	1700							
5	5SB	1800		111		21			M8 x 50
6	6SBT1	2500		137		22		55	M10 x 50
7	7SB	2500	13/8" Z6	143	22	45	M10 x 60		
	7SBT1	3000				49	M12 x 60		
8	8SB			3500	13/4" Z6	148	20	60	M10 x 60
	8SBT1	57						M12 x 60	
	8SBT1.C	57	M12 x 60						
38	SB		13/8" Z6	147		20	M10 x 60		

FRICTION TORQUE LIMITER WITH 2 FRICTION DISCS

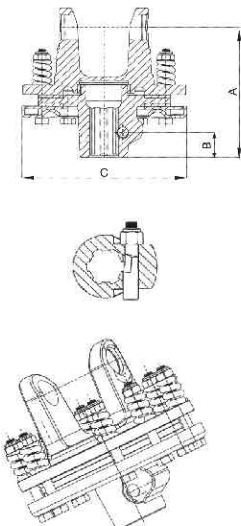

SIZE	REF	MAX TORQUE Nm	FRICTION DISC	SPLINE (FEMALE)	A (mm)	B (mm)	C (mm)
5	5FF2	Ø 1500	140	13/8"Z6	170	29	Ø 180
	5FF3.D			13/8"Z21			
6	6FF2V3			178	13/8"Z6		
	6FF2V3.D				13/8"Z21		
	6FF2V3.C				13/8"Z6		
	6FF2V3.E				13/8"Z20		
5	5FF2	Ø 1200	160	13/8"Z6	154	29	Ø 200
	5FF2.D			13/8"Z21			
6	6FF2			13/8"Z21			
	6FF2.C			13/8"Z6			
	6FF2.E			13/8"Z20			
8	8FF2						
	8FF2.D	13/8"Z21					
	8FF2.C	13/8"Z6					
	8FF2.E	13/8"Z20					



FRICTION TORQUE LIMITER WITH 4 FRICTION DISCS

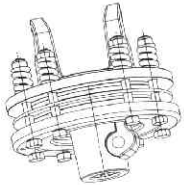
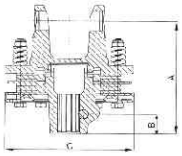

SIZE	REF	MAX TORQUE Nm	FRICTION DISC	SPLINE (FEMALE)	A (mm)	B (mm)	C (mm)
5	5FF2	1500	Ø 140	13/8"Z6	170	29	Ø 180
	5FF3.D			13/8"Z21			
6	6FF3			13/8"Z6	178		
	6FF3.D			13/8"Z21			
	6FF3.C			13/4"Z6			
	6FF3.E			13/4"Z20			
6	6FF4			13/8"Z6	178		
	6FF4.D			13/8"Z21			
	6FF4.C			13/4"Z6			
	6FF4.E			13/4"Z20			
8	8FF4	13/8"Z6	186				
	8FF4.D	13/8"Z21					
	8FF4.C	13/4"Z6					
	8FF4.E	13/4"Z6					

SPARES



We stock original and essential spares to service our large list of clients and keep their machines operating for an extensive time. Our range includes 3 lobe telescopic tubes, yokes (both 6 & 21 splines), cross and Shear bolt torque limiters/ Friction Torque Limiters.

OUR OTHER PRODUCTS:



ETP Keyless Bush,
Sweden



Universal Joints,
Italy



MAV Locking Assemblies/ Shrink
Discs, Italy



STS Metal Bellow
Couplings, Germany



Samiflex Couplings,
Spain



Hutchinson Poly V Belts,
France



Planetroll Gearbox,
Germany



Bamatech Spring Couplings,
Switzerland

TRADELINK SERVICES

Mechanical Power Transmission Engineers
5 South Phase
Ambattur Industrial Estate
Chennai 600 058

Tel : 91 (44)26231267/26242184
Fax : 91 (44) 28361741
Email : tradelink@vsnl.com
tradelinkchn@gmail.com
Web : www.tradelinkservices.net
www.tradelinkservices.in

We Bring Perfection To Transmission

